



## SSCN143GS6

### NPN Type Digital Transistor (built-in resistors)

#### ➤ Features

VCC	VIN	IO	R1	R2/R1 Typ.
50V	-5~+30V	100mA	4.7kΩ	10

#### ➤ Description

Built-in bias resistors enable the configuration of an inverter circuit without connecting external input resistors (see equivalent circuit).

The bias resistors consist of thin-film resistors with complete isolation to allow negative biasing of the input. They also have the advantage of almost completely eliminating parasitic effects. Only the on/off conditions need to be set for operation, making the device design easy.

#### ➤ Applications

- Amplifying signal
- Electronic switch
- Oscillating circuit
- Variable resistance

#### ➤ Ordering Information

Device	Package	Shipping
SSCN143GS6	SOT-23	3000/Reel

#### ➤ Pin configuration

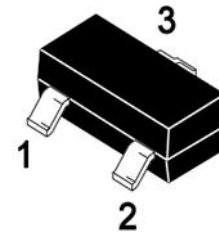

**SOT-23**

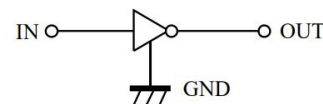
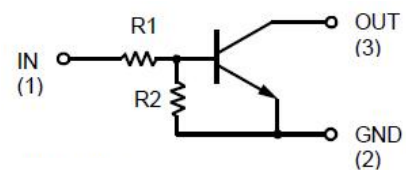

**Circuit Diagram**

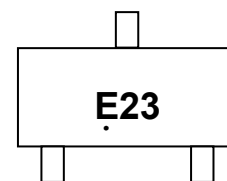

**Marking (Top View)**



➤ **Absolute Maximum Ratings**( $T_A=25^{\circ}\text{C}$  unless otherwise noted)

Parameter	Symbol	Value	Unit
Supply Voltage	$V_{CC}$	50	V
Input Voltage	$V_{CN}$	-5 to +50	V
Output current	$I_o$	100	mA
Power Dissipation	$P_D$	200	mW
Junction Temperature	$T_J$	-55 to 150	$^{\circ}\text{C}$
Storage Temperature	$T_{STG}$	-55 to 150	$^{\circ}\text{C}$

➤ **Electrical Characteristics** ( $T_A=25^{\circ}\text{C}$  unless otherwise noted)

Parameter	Symbol	Test Conditions	Min.	Typ.	Max.	Unit
Input Voltage	$V_{I(off)}$	$V_{CC} = 5V, I_o = 0.1mA$	0.5			V
	$V_{I(on)}$	$V_{CC} = 0.3V, I_o = 5mA$			1.3	V
Output Voltage	$V_{O(on)}$	$I_o/I_i = 5mA/0.25mA$		0.1	0.3	V
Input Current	$I_i$	$V_i = 5V$			1.8	mA
Output Current	$I_{O(off)}$	$V_{CC} = 50V, V_i = 0V$			0.5	uA
DC Current Gain	$G_1$	$V_o = 5V, I_o = 10mA$	80			
Input Resistance	$R_1$		3.29	4.7	6.11	K $\Omega$
Resistance Ration	$R_2/R_1$		8	10	12	
Transition Frequency	$f_T$	$V_o = 10V, I_o = 5mA, f = 100MHz$		250		MHz



➤ Typical Performance Characteristics ( $T_A=25^\circ\text{C}$  unless otherwise noted)

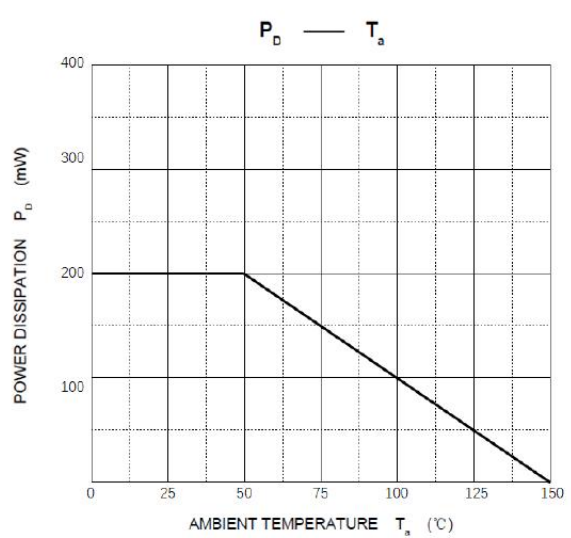
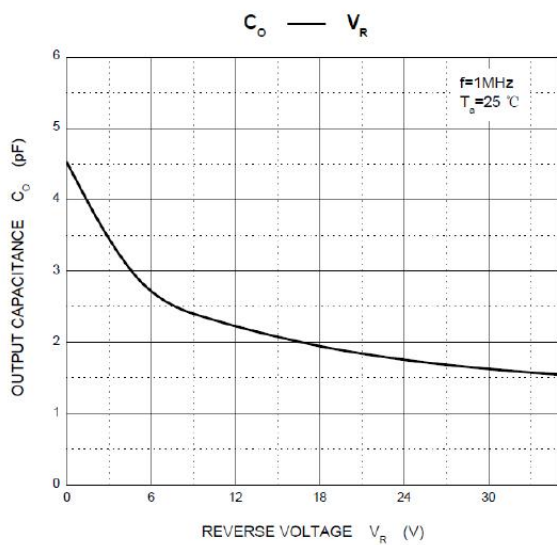
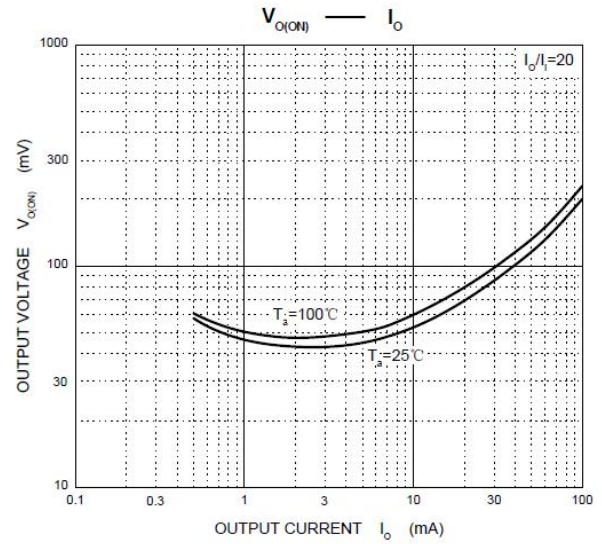
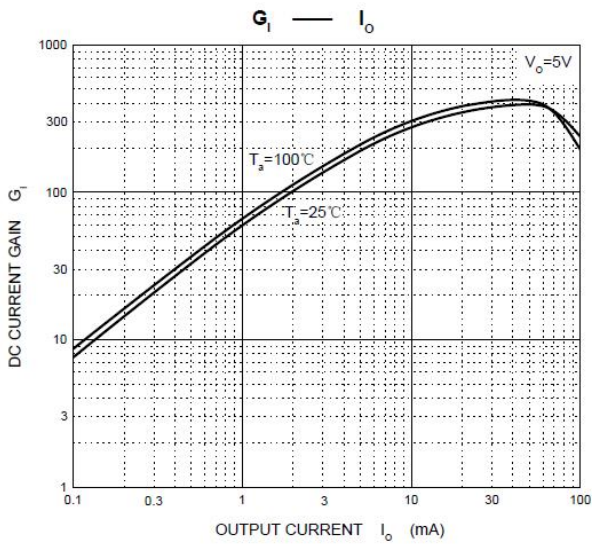
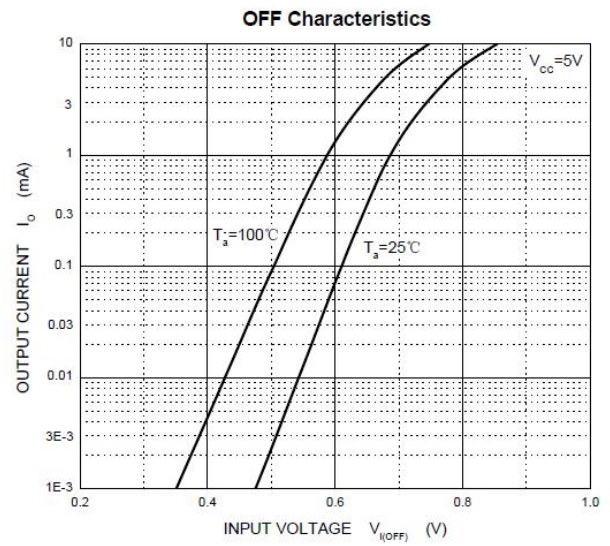
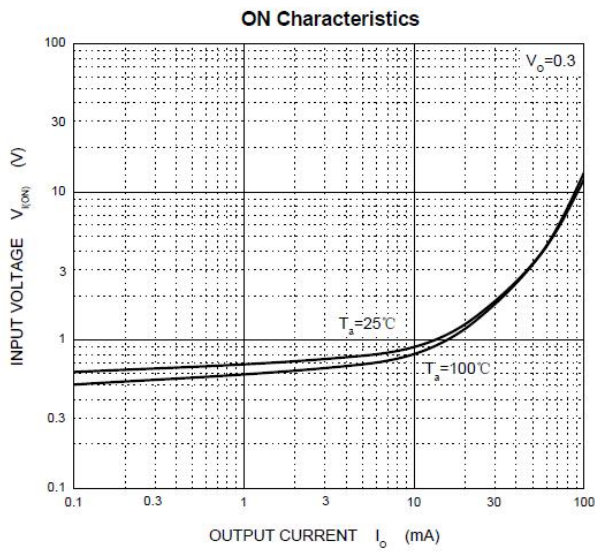

➤ Package Information

● Mechanical Data

**SOT-23**

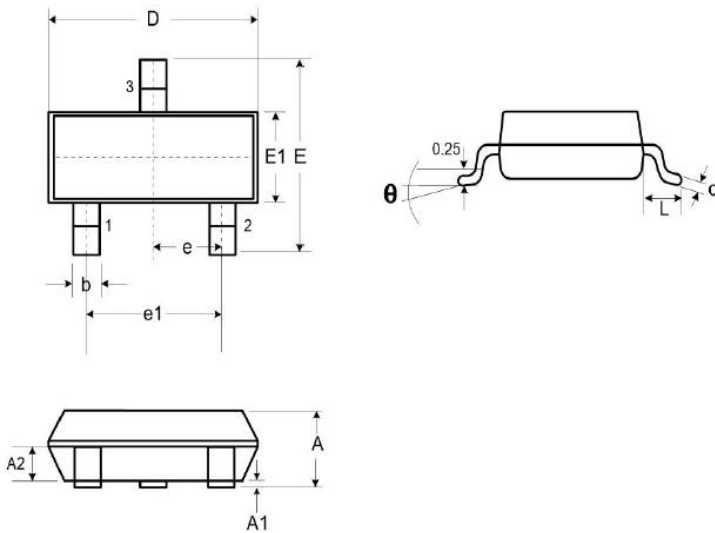

DIM	Millimeters		
	Min.	Typ.	Max.
<b>A</b>	0.89	-	1.12
<b>A1</b>	0.01	-	0.10
<b>A2</b>	0.88	0.95	1.02
<b>b</b>	0.30	-	0.51
<b>c</b>	0.08	-	0.18
<b>D</b>	2.80	2.90	3.04
<b>E</b>	2.10	2.37	2.64
<b>E1</b>	1.20	1.30	1.40
<b>e</b>	1.90		
<b>e1</b>	0.95		
<b>L</b>	0.40	0.50	0.60
<b>L1</b>	0.55		
<b>N</b>	3		
<b>θ</b>	0°	-	8°

● Recommended Pad outline (Unit: mm)

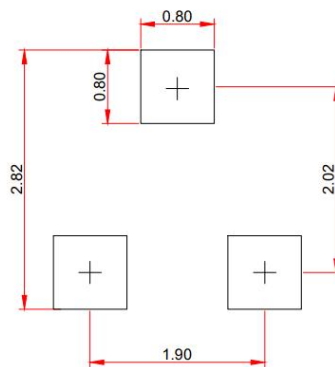



## DISCLAIMER

SSCSEMI RESERVES THE RIGHT TO MAKE CHANGES WITHOUT FURTHER NOTICE TO ANY PRODUCTS HEREIN TO IMPROVE RELIABILITY, FUNCTION OR DESIGN. SSCSEMI DOES NOT ASSUME ANY LIABILITY ARISING OUT OF THE APPLICATION OR USE OF ANY PRODUCT OR CIRCUIT DESCRIBED HEREIN; NEITHER DOES IT CONVEY ANY LICIENCE UNDER ITS PATENT RIGHTS, NOR THE RIGHTS OF OTHERS.

THE GRAPHS PROVIDED IN THIS DOCUMENT ARE STATISTICAL SUMMARIES BASED ON A LIMITED NUMBER OF SAMPLES AND ARE PROVIDED FOR INFORMATIONAL PURPOSE ONLY. THE PERFORMANCE CHARACTERISTICS LISTED IN THEM ARE NOT TESTED OR GUARANTEED. IN SOME GRAPHS, THE DATA PRESENTED MAY BE OUTSIDE THE SPECIFIED OPERATING RANGE (E.G. OUTSIDE SPECIFIED POWER SUPPLY RANGE) AND THEREFORE OUTSIDE THE WARRANTED RANGE.

OUR PRODUCT SPECIFICATIONS ARE ONLY VALID IF OBTAINED THROUGH THE COMPANY'S OFFICIAL WEBSITE, CRM SYSTEM, OR OUR SALES PERSONNEL CHANNELS. IF CHANGES OR SPECIAL VERSIONS ARE INVOLVED, THEY MUST BE STAMPED WITH A QUALITY SEAL AND MARKED WITH A SPECIAL VERSION NUMBER TO BE VALID.