



SSCE5V041SB

Ultra Low Capacitance Array for ESD Protection

● Description

The SSCE5V041SB is a high performance and low-cost design which includes surge rated diode arrays to protect high speed data interfaces. The SSCE5V041SB family has been specifically designed to protected sensitive components. Which are connected to data and transmission lines, from over-voltage caused by Electrostatic Discharging (ESD). Electrical Fast Transients (EFT), and lightning.

The SSCE5V041SB is a unique design which includes surge rated, low capacitance steering diodes and a unique design of clamping cell which is an equivalent TVS diodes in a single package. During transient conditions, the steering diodes direct the transient to either the power supply line or to the ground line. The internal unique design of clamping cell prevents over-voltage on the power line, protecting any downstream components. The SSCE5V041SB may be used to meet the ESD immunity requirements of IEC 61000-4-2, level 4(±15KV air, ±10KV contact discharge).

● Feature

- ✧ 60W peak pulse power ($t_P = 8/20\mu s$)
- ✧ SOT23-6L Package
- ✧ Working voltage: 5V
- ✧ Low clamping voltage
- ✧ Low capacitance
- ✧ Low leakage current
- ✧ Response Time is <1 ns
- ✧ RoHS compliant
- ✧ Complies with following standards:
 - IEC 61000-4-2 (ESD) immunity test
Air discharge: ±15kV
Contact discharge: ±10kV
 - IEC 61000-4-5(Surge) 3A (8/20μs)

● PIN configuration

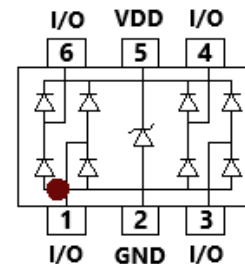

Circuit Diagram

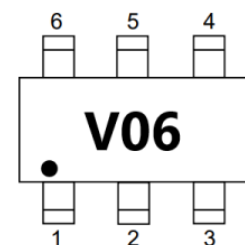

Marking (Top View)

● Applications

- ✧ Video Graphics Cards
- ✧ USB2.0 Power and Data lines protection
- ✧ Notebook and PC Computers
- ✧ Monitors and Flat Panel Displays
- ✧ IEEE 1394 Firewire Ports
- ✧ SIM Ports

● Mechanical data

- ✧ Lead finish: 100% matte Sn (Tin)
- ✧ Mounting position: Any
- ✧ Qualified max reflow temperature: 260°C
- ✧ Device meets MSL 3 requirements
- ✧ Pure tin plating: 7 ~ 17 μm
- ✧ Pin flatness: ≤3mil



● Electronic Parameter

Symbol	Parameter
V_{RWM}	Peak Reverse Working Voltage
I_R	Reverse Leakage Current @ V_{RWM}
V_{BR}	Breakdown Voltage @ I_T
I_T	Test Current
I_{PP}	Maximum Reverse Peak Pulse Current
V_C	Clamping Voltage @ I_{PP}
P_{PP}	Peak Pulse Power
C_J	Junction Capacitance

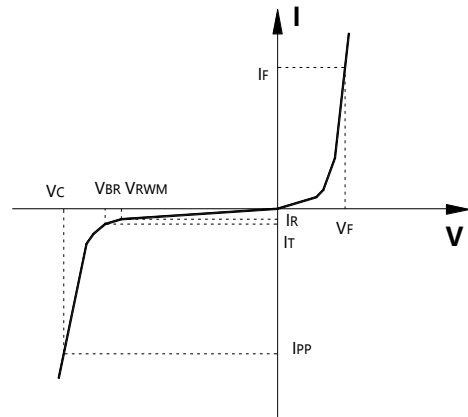

● Absolute maximum rating @ $T_A = 25^\circ C$

Parameter	Symbol	Value	Unit
Peak Pulse Power (8/20 μs)	P_{PP}	60	W
Peak Pulse Current (8/20 μs)	I_{PP}	3	A
ESD Rating per IEC61000-4-2:	Contact	10	KV
	Air	15	
Storage Temperature	T_{STG}	-55/+150	$^\circ C$
Operating Temperature	T_J	-55/+125	$^\circ C$

● Electrical Characteristics @ $T_A = 25^\circ C$

Parameter	Symbol	Conditions	Min.	Typ.	Max.	Unit
Peak Reverse Working Voltage	V_{RWM}				5	V
Breakdown Voltage	V_{BR}	$I_T = 1mA$	6.0			V
Reverse Leakage Current	I_R	$V_{RWM} = 5V$			1	μA
Clamping Voltage (I/O pin to GND)	V_{C1}	$I_{PP} = 1A, t_P = 8/20\mu s$		8.8	12	V
	V_{C2}	$I_{PP} = 3A, t_P = 8/20\mu s$		10.8	14	V
Clamping Voltage (VDD pin to GND)	V_C	$I_{PP} = 10A, t_P = 8/20\mu s$			16	V
Junction Capacitance	C_J	$V_R = 0V, f = 1MHz,$ between I/O pins		0.25	0.5	pF
Junction Capacitance	C_J	$V_R = 0V, f = 1MHz,$ I/O pins pin to GND		0.4	0.9	pF



● Typical Performance Characteristics

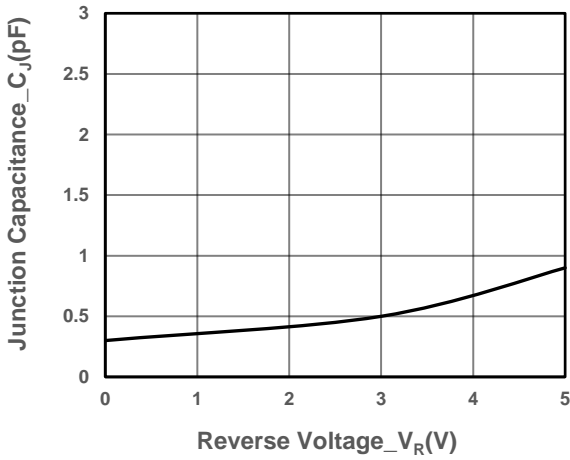

Junction Capacitance vs. Reverse Voltage

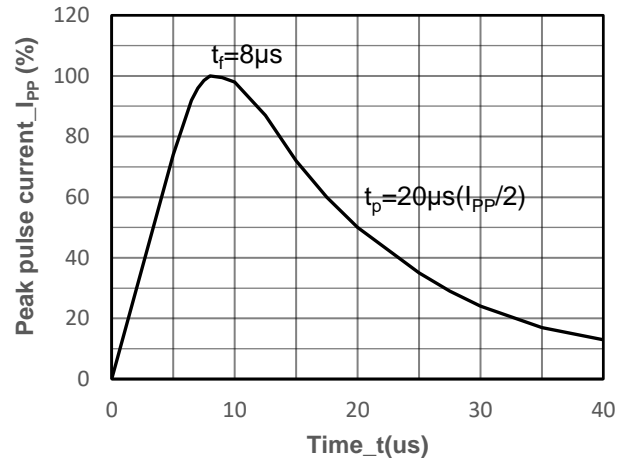

8/20 μs Pulse Waveform

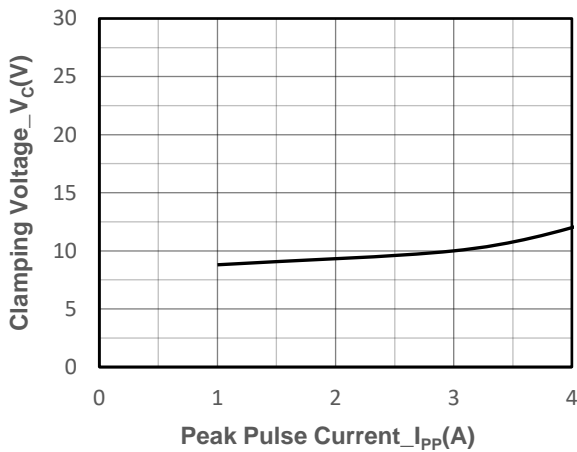

Clamping Voltage vs. Peak Pulse Current

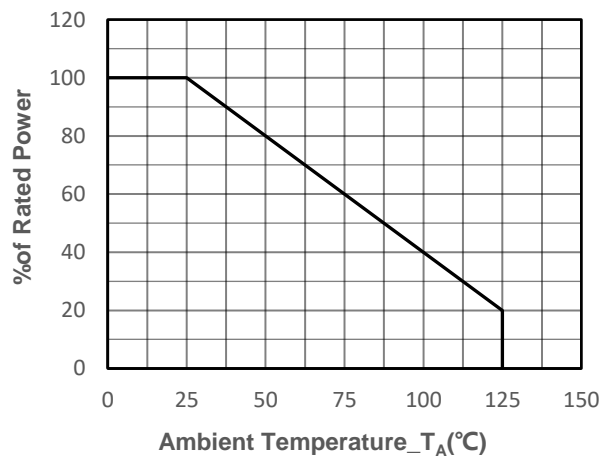

Power derating vs. Ambient temperature



● Package Information

Ordering Information

Device	Package	Qty per Reel	Reel Size
SSCE5V041SB	SOT23-6L	3000	7 Inch

Mechanical Data

Case: SOT23-6L

Case Material: Molded Plastic. UL Flammability

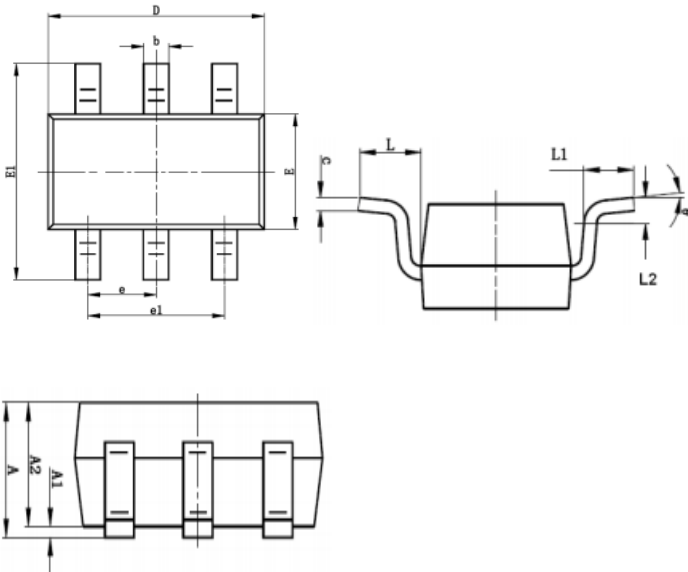

DIM	Millimeters	
	Min	Max
A	0.900	1.450
A1	0.000	0.150
A2	0.900	1.300
b	0.300	0.500
c	0.080	0.210
D	2.720	3.120
E	1.400	1.800
E1	2.600	2.950
e	0.950BSC	
el	1.9BSC	
L1	0.300	0.600
L	0.7REF	
L2	0.25REF	
θ	0	8

Recommended Pad outline (Unit: mm)

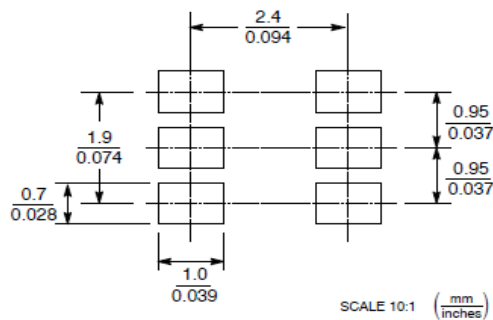



DISCLAIMER

SSCSEMI RESERVES THE RIGHT TO MAKE CHANGES WITHOUT FURTHER NOTICE TO ANY PRODUCTS HEREIN TO IMPROVE RELIABILITY, FUNCTION OR DESIGN. SSCSEMI DOES NOT ASSUME ANY LIABILITY ARISING OUT OF THE APPLICATION OR USE OF ANY PRODUCT OR CIRCUIT DESCRIBED HEREIN; NEITHER DOES IT CONVEY ANY LICIENCE UNDER ITS PATENT RIGHTS, NOR THE RIGHTS OF OTHERS.

THE GRAPHS PROVIDED IN THIS DOCUMENT ARE STATISTICAL SUMMARIES BASED ON A LIMITED NUMBER OF SAMPLES AND ARE PROVIDED FOR INFORMATIONAL PURPOSE ONLY. THE PERFORMANCE CHARACTERISTICS LISTED IN THEM ARE NOT TESTED OR GUARANTEED. IN SOME GRAPHS, THE DATA PRESENTED MAY BE OUTSIDE THE SPECIFIED OPERATING RANGE (E.G. OUTSIDE SPECIFIED POWER SUPPLY RANGE) AND THEREFORE OUTSIDE THE WARRANTED RANGE.

OUR PRODUCT SPECIFICATIONS ARE ONLY VALID IF OBTAINED THROUGH THE COMPANY'S OFFICIAL WEBSITE, CRM SYSTEM, OR OUR SALES PERSONNEL CHANNELS. IF CHANGES OR SPECIAL VERSIONS ARE INVOLVED, THEY MUST BE STAMPED WITH A QUALITY SEAL AND MARKED WITH A SPECIAL VERSION NUMBER TO BE VALID.